



Spa & Hot Tub Necessities

*Premium Top Mount Hydraulic  
Cover Removal System  
Installation & Use Manual*



# WARNING

PLEASE READ ALL INSTRUCTIONS BEFORE  
ATTEMPTING INSTALLATION

FAILURE TO DO SO MAY CAUSE PERSONAL INJURY OR DAMAGE TO YOUR LIFT  
AND/OR SPA COVER

**BEFORE YOU START: Determine whether spa will need a Top Mount or a Side Mount installation.**

## 1. PARTS LIST

The following parts are included in your CRS4 Cover Lift package:

Two (2) Pre-assemble Pivot Assemblies

1 - Left

1 - Right

Two (2) Side Mount Brackets

Two (2) Lock Knobs

Ten (10) 3/4" Hex Bolts

Ten (10) Flat Washers

Twelve (12) Nylock Nuts

Eight (8) 1-1/4" Lag Bolts

Two (2) Phillips Pan Head Screws

Two (2) Handle Bars

One (1) Torsion Bar

## 2. TOOL LIST

The following are needed to install your CRS4 Cover Lift.

Power drill with 1/4" drill bit

1/2" open wrench

1/2" socket wrench

Phillips head screw driver

9/16" socket wrench

Awl

Tape Measure

### Wear Protective Eye Wear

**WARNING:** All hardware must be properly tightened before operation of lift. Failure to do so may result in injury or damage to lift/spa.



## CAUTIONS

Extreme Caution:

- Be sure to use extreme caution during the Hydraulic Lift Arm phase of the assembly. A potential for sudden impact is possible.
  - Do not cut the red retaining straps until instructed to do so.
  - **BEFORE ASSEMBLY:** Make sure there are no overhead objects that could interfere with the cover's designed operation (lights, wires, branches, etc.).
1. Be sure to read all installation steps before beginning.
  2. Many steps only show the installation of your cover lifter on one side of your hot tub.
  3. To complete your installation, repeat the same steps on the opposite side of your hot tub.

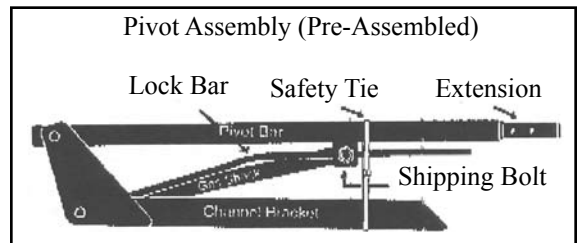

### 3. DETERMINING WHICH TYPE OF INSTALLATION IS RIGHT FOR YOUR HOT TUB

1. PLEASE consider the following before installing your Cover Lift:
  - a. The **Channel Bracket** (pre-assembled **Pivot Assembly**) should be mounted 2 - 5 " from the back edge of your hot tub.
  - b. The **Pivot Assembly** should not interfere with your hot tub cover.
  - c. Determine whether or not the **Side Mount Brackets** are necessary for installing the Cover Lift to your hot tub. (See A & B below)

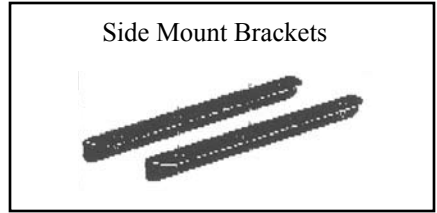

- A.** Use the **Side Mount Brackets** to assemble your Cover Lift when:
- a. the top rail around your hot tub is not wide enough to accomodate the **Channel Bracket** of the **Pivot Assembly** OR
  - b. the Cover Lift is the same size or wider than the wood rim of your hot tub's cabinet.

- B.** **DO NOT** use the **Side Mount Brackets** to assemble your Cover Lift when:
- a. the **Channel Brackets** of the **Pivot Assembly** can be mounted directly to the deck of an in-ground hot tub
  - b. OR the **Channel Brackets** can be mounted directly to the top of your hot tub's cabinet without interfering with the Cover Lift.

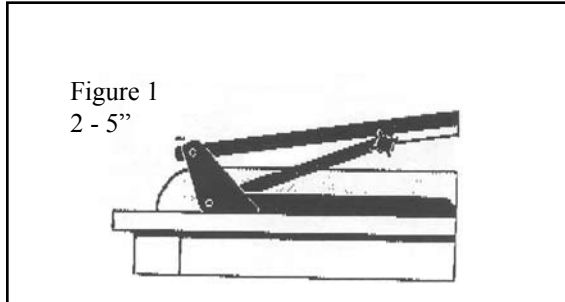

**Channel Bracket** is mounted directly to the top of the wood rim of the cabinet. The cover moves freely between the cover lift and hot tub.

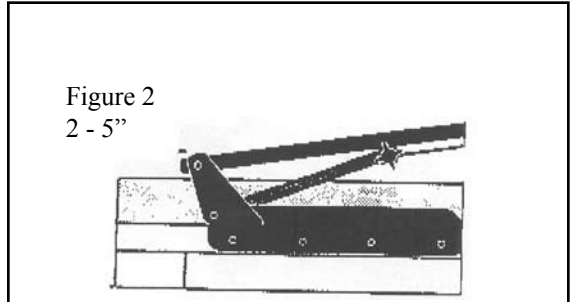

**Side Mount Bracket** is mounted to the side of the hot tub's cabinet in order to leave room for a cabinet size cover.

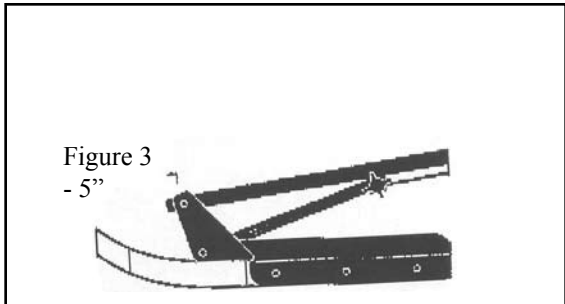

**Side Mount Bracket** is mounted to the side of the hot tub's top rail on the first flat surface approximately 2" - 5" from the corner of the hot tub.

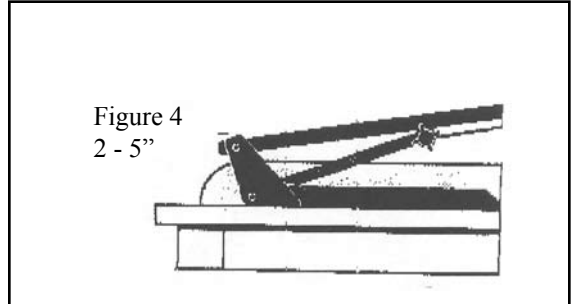

**Channel Bracket** is offset of the top of a **Side Mount Bracket**, bringing the **Pivot Assembly** 2" - 5" from the back edge of the hot tub cover.

# ASSEMBLY

## A. Mounting Brackets

1. Install Mounting Brackets so that when the cover is lifted it is on the side opposite the control panel of the hot tub.
2. Measure 1-1/2" from end of cabinet edge from kitty corner flush to cut line. (fig. 1)
3. Mark holes, on center, with marker on both sides of the hot tub. (figure 1)
4. Use one bracket or level to level the bracket while marking and drilling holes.
5. Drill holes on bracket marks to a depth of 3/4" using 1/4" drill bit
6. Using a 1/2" socket wrench, install Mounting Brackets with screws provided

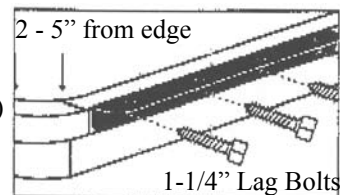

Figure 1

## B. Hydraulic Lift Arm

**EXTREME CAUTION:** Be sure to use extreme caution during this phase of assembly. A potential for sudden impact is possible. **Do not cut the RED retaining straps until instructed to do so.**

1. Using a 9/16" socket wrench, loosen the nut (shipping bolt) marked "Under pressure". (see figure 2)
2. Remove the Shipping Bolt and replace it with the **Lock Knob** making sure that the conical spring washers are facing concaved sides towards each other (see figure 3)
3. Tighten the **Lock Knob** till it offers firm resistance
4. Making sure **Extension Bar** is pointed away from your face and other body parts.
5. Make sure **Lock Knob** is tightened.
6. Cut RED retaining strap and discard strap.
7. The Gas Shock of the **Pivot Assembly** is under pressure. Use extreme caution on steps 8 and 9.
8. Placing **Channel Bracket** on ground, place hand over **Extension Bar** and exert force downward while slowly loosening the **Lock Knob**.
9. Gently release pressure exerted from hand on **Extension Bar** assembly and allow the gas shock to expand to full extension.

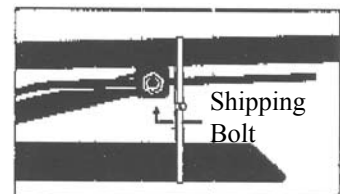

Figure 2

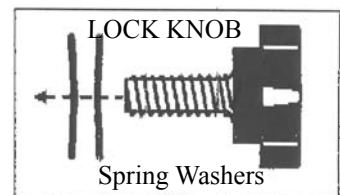

Figure 3

## C. Pivot Assembly Installation

### ***Side Mount Bracket Installation***

1. With **Pivot Assembly** fully expanded, place five (5) 1/2" bolts with washers through holes in Assembly and **Side Mount Bracket** carefully lining up same. (figure 4)
2. Secure with **Nylock Nuts** but DO NOT TIGHTEN
3. Once bolts are in place, slide assemblies as far away from the sides of cabinet as it will go.
4. Tighten bolts starting with the center bolt and alternating till all bolts are tightened down.

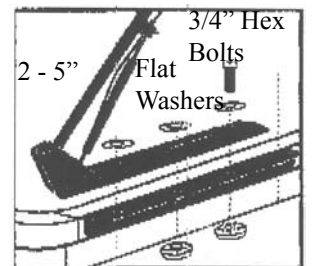

Figure 4

### ***No Side Mount Bracket Required Installation***

1. With **Pivot Assembly** fully expanded, place five (5) 1/2" bolts with washers through holes in Assembly and line up carefully with holes in top or side of hot tub cabinet. (figure 5)
2. Secure with **Nylock Nuts** but DO NOT TIGHTEN
3. Tighten bolts starting with the center bolt and alternating till all bolts are tightened down.

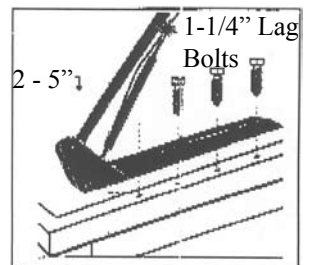
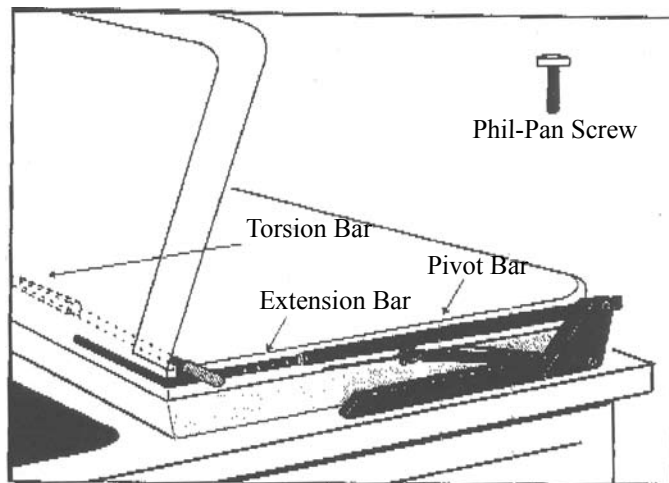

Figure 5

# ASSEMBLY

## D. Cover Assembly

1. Gently place the folded Cover Lift cover on top of hot tub with the cover's seam (fold) facing the control panel so that the flap on the cover is flush with the edge of the cabinet.
2. Loosen the **Lock Knob** and pull the extension Arm to a horizontal position.
3. Using a phillips head screw driver, remove the screw and nut from the adjustable arm.
4. Now, slide the **Extension Arm** until it sits between the fold's flaps along the cover's fold seam. (figure 6)
5. Line up the hole in the adjustable arm and replace the screw and nut.
6. Now, flip the one half of the folded cover over until it covers the remainder of the hot tub.
7. Take one of the **Handle Bars** and insert it into the top of the **Molded Saddle**, located on the end of the **Extension Bar**.
8. Using a 2-1/2" bolt and **Nylock Nut**, fasten the **Handle Bar** to the **Extension Bar**. Be sure to tighten until at least one thread of the bolt is through the **Nylock Nut**.
9. Insert the **Torsion Bar** into squared end of the mounted **Handle Bar**, then insert the opposite end of the **Torsion Bar** into the remaining **Handle Bar**. **Be sure to put equal amounts of the Torsion Bar into each Handle Bar.**
10. Using a 2-1/2" bolt and **Nylon Nut**, secure the other **Handle Bar** to the **Molded Saddle** of the remaining **Extension Arm**.



# OPERATION

## A. Lifting

1. Before lifting the cover, make sure there is nothing on the cover.
2. Look to see that there is no overhead obstruction that could interfere with the covers trajectory (lights, wires, branches, etc...)
3. To lift the cover, simply grab a hold of either **Handle Bar**, and lift in an upward motion.
4. The hydraulic arm of the Cover Lift will provide the necessary power to assist in lifting the cover.
5. Bring cover to its full upright position, the cover will hang slightly toward the hot tub, tighten the lock knob for extra secure hold of raised cover. Loosen knob to lower and tighten again when closed.
6. The Cover Lift cover provides excellent heat retention when in place, and acts as a sound baffle and privacy screen when in the lift position.

# HARDWARE CHART

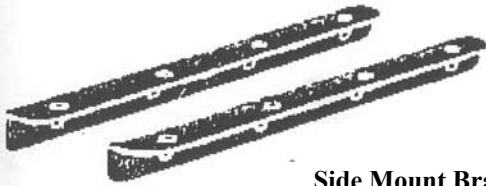
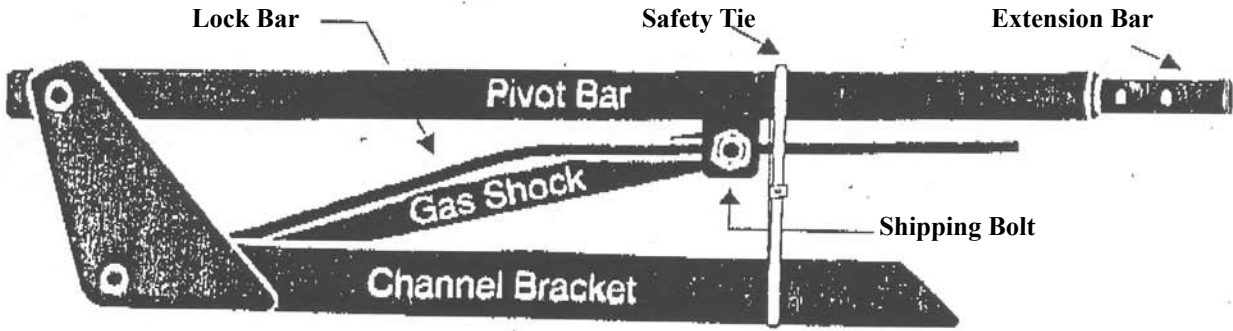

Side Mount Brackets



Handle Bar



Torsion Bar

Lock Knob

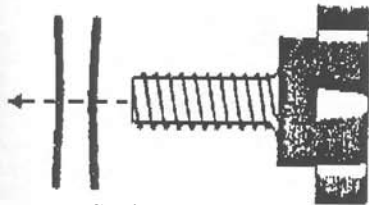

Spring Washers



Nylock Nut



Under Hinge Bar



Flat Washer

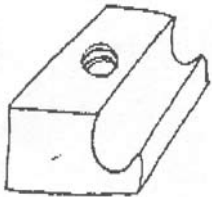

Aluminum Clamp



3/4" Hex Bolt



Phil-Pan Screw

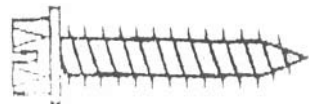

1-1/4" Lag Bolt

## **5 YEAR LIMITED WARRANTY**

**SPAccessories** warrants this product to be free from defects in workmanship and material, under normal use and service conditions, for a Limited 5 Year Warranty. This warranty extends only to the original purchaser. **SPAccessories'** obligation under this warranty is limited to replacing or repairing, at **SPAccessories'** option, the product at one of its authorized service centers. All products for which warranty claim is made must be received by **SPAccessories** at one of its authorized service centers with all freight and other transportation charges prepaid, accompanied by sufficient proof of purchase. All returns must be pre-authorized by **SPAccessories**. This warranty does not extend to any product or damage to a product caused by or attributable to freight damage, abuse, misuse, improper or abnormal usage or repairs not provided by a **SPAccessories** authorized service center, products used for commercial or rental purposes, or products used as store display models. No other warranty beyond that specifically set forth above is authorized by **SPAccessories**.

**SPAccessories** is not responsible or liable for indirect, special or consequential damages arising out of or in connection with the use or performance of the product or damages with respect to any economic loss, loss of property, loss or revenues or profits, loss of enjoyment or use, costs of removal, installation or other consequential damages of whatsoever nature. Some states do not allow the exclusion or limitation of incidental or consequential damages. Accordingly, the above limitation may not apply to you.

The warranty extended hereunder is in lieu of any and all other warranties and any implied warranties of merchantability or fitness for a particular purpose is limited in its scope and duration to the terms set forth herein. Some states do not allow limitations on how long an implied warranty lasts. Accordingly, the above limitation may not apply to you.

This warranty gives you specific legal rights. You may also have other rights which vary from state to state.

**SPAccessories**, 6848 S. Airport Rd., West Jordan, UT 84084



Spa & Hot Tub Necessities

---

6848 S. Airport Road ~ West Jordan, UT 84084